

U. S. DEPARTMENT OF  
AGRICULTURE

FARMERS' BULLETIN No. 1638

RAT PROOFING  
BUILDINGS *and*  
PREMISES



U. S. DEPARTMENT OF  
AGRICULTURE  
FARMERS' BULLETIN No. 1638

RAT PROOFING  
BUILDINGS *and*  
PREMISES

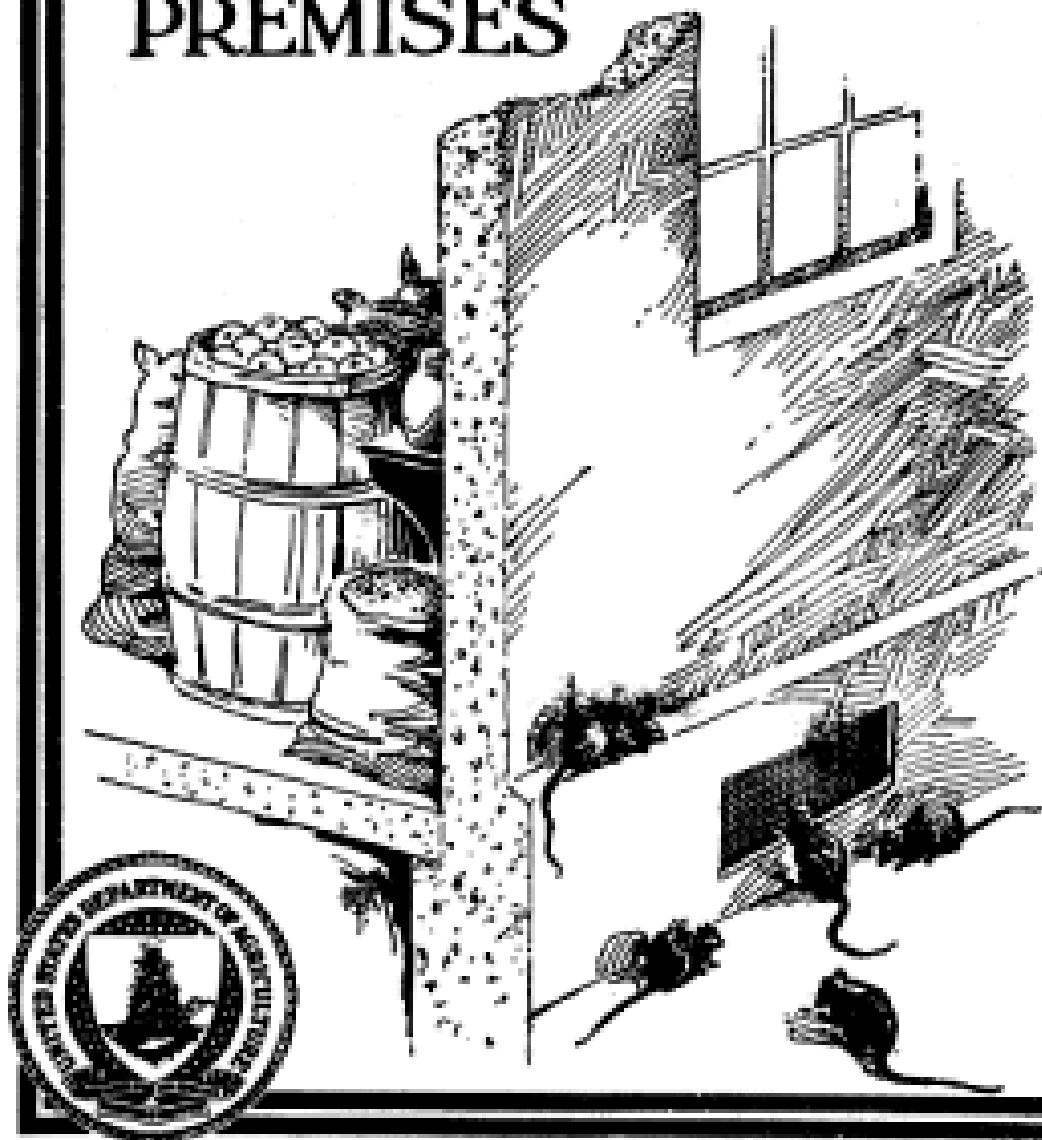

**The Project Gutenberg eBook of Rat Proofing  
Buildings and Premises**

This eBook is for the use of anyone anywhere in the United States and most other parts of the world at no cost and with almost no restrictions whatsoever. You may copy it, give it away or re-use it under the terms of the Project Gutenberg License included with this eBook or online at [www.gutenberg.org](http://www.gutenberg.org). If you are not located in the United States, you will have to check the laws of the country where you are located before using this eBook.

Title: Rat Proofing Buildings and Premises

Author: James Silver  
M. C. Betts  
W. E. Crouch

Release date: July 10, 2020 [eBook #62608]  
Most recently updated: October 18, 2024

Language: English

Other information and formats:  
[www.gutenberg.org/ebooks/62608](http://www.gutenberg.org/ebooks/62608)

Credits: Produced by Tom Cosmas

\*\*\* START OF THE PROJECT GUTENBERG EBOOK RAT  
PROOFING BUILDINGS AND PREMISES \*\*\*

**U. S. DEPARTMENT OF  
AGRICULTURE**

**FARMERS' BULLETIN  
No. 1638**

**RAT PROOFING  
BUILDINGS and  
PREMISES**

**F**OOD AND SHELTER are as essential to rats as to other animals, and the removal of these offers a practical means of permanent rat control. The number of rats on premises and the extent of their destructiveness are usually in direct proportion to the available food supply and to the shelter afforded. Rat proofing in the broadest sense embraces not only the exclusion of rats from buildings of all types but also the elimination of their hiding and nesting places and cutting off their food supply. Through open doors and in other ways, rats may frequently gain access to structures that are otherwise rat proof, but they can not persist there unless they find safe retreats and food. When rat proofing becomes the regular practice the rat problem will have been largely solved.

---

Washington, D. C.

Issued December, 1930

# RAT PROOFING BUILDINGS AND PREMISES

By JAMES SILVER, *Associate Biologist*, and W. E. CROUCH, *Senior Biologist, Division of Predatory-Animal and Rodent Control, Bureau of Biological Survey*, and M. C. BETTS, *Senior Architect, Division of Agricultural Engineering, Bureau of Public Roads*.

## CONTENTS

	Page
Introduction	<a href="#">1</a>
General principles of rat proofing	<a href="#">2</a>
Rat-proofing farm buildings	<a href="#">2</a>
Barns	<a href="#">5</a>
Corncribs	<a href="#">7</a>
Granaries	<a href="#">9</a>
Poultry houses	<a href="#">9</a>
Other farm structures	<a href="#">11</a>
Rat proofing city buildings	<a href="#">13</a>
Markets	<a href="#">18</a>
Warehouses	<a href="#">19</a>
Rat proofing the city	<a href="#">20</a>
Model rat-proofing ordinances	<a href="#">21</a>

---

## INTRODUCTION

**T**HE PRINCIPLES of modern construction of buildings are opposed to everything conducive to the best interests of the rat. They call for the liberal use of indestructible and noncombustible materials, as well-made concrete and steel, and these are too much for even the sharpest of rodent incisors. They include, also, fire stopping in double walls and floors and the elimination of all dead spaces and dark corners, and the rat is left no place in which to hide. They embody sanitary features that provide for hygienic storage of food, and the rat can not live without something to eat.

Many men have devoted their lives to a study of methods of rat control, and as a result countless preparations, devices, and contrivances are constantly being made available. Trapping, snaring, trailing, flooding, digging, hunting, ferreting, poisoning, and fumigating are employed, and rat limes, rat lures, rat repellents, and bacterial viruses are resorted to, and even antirat laws, local, State, and national, are constantly being passed in a world-wide effort to conquer this rodent. These have been important factors in keeping down the surplus, but all destructive agencies that have been used have utterly failed to reduce materially the total number of rats in the world. Rat proofing, however, is at last making definite headway against the age-old enemy of mankind, and it is upon this that the ultimate solution of the rat problem will depend.

The destruction of rats for temporary relief and for keeping them under control in places where rat proofing is not possible or practicable will always be necessary, and knowledge of the best means of destroying rats is essential to any rat-control program. Information on poisoning, trapping, and other means of destroying rats is given in Farmers' Bulletin 1533, Rat Control. Permanent freedom from rats, however, should be the goal of everyone troubled with the pests and rat proofing offers the best means to this end.

---

# GENERAL PRINCIPLES OF RAT PROOFING

Every separate structure presents its individual problem, but there are two general principles that apply in all cases and that should be kept in mind when the rat proofing of any building is being considered. First, the exterior of those parts of the structure accessible to rats, including porches or other appurtenances, must be constructed of materials resistant to the gnawing of rats, and all openings must be either permanently closed or protected with doors, gratings, or screens; second, the interior of the building must provide no dead spaces, such as double walls, spaces between ceilings and floors, staircases, and boxed-in piping, or any other places where a rat might find safe harborage, unless they are permanently sealed with impervious materials.

All new buildings should be made rat proof. When plans are being drawn for a building, the rat problem is frequently overlooked, usually because rats are not often present near sites selected for new structures. They are certain to come later, however, and should therefore be taken into account. Modern structures are so nearly rat proof that to make them completely so requires only slight and inexpensive changes. Furthermore, rat proofing is closely associated with fire stopping and with sanitary measures that are now required by law in many places. Cities in growing numbers have added rat proofing clauses to their building ordinances with such good effect that others are sure to follow their lead. Builders should therefore compare the cost of rat proofing during construction with the probable later cost, in case local laws should require that all buildings be made rat proof.

## RAT PROOFING FARM BUILDINGS

The cost of rat proofing the entire premises of many American farms would amount to less than the loss occasioned by rats on the same farms during a single year. In no other place is rat proofing more badly needed or less often accomplished than on the farm. There are, however, numerous examples of rat-proof farms in nearly every county in the United States, and almost invariably they are the more prosperous farms, for the rat proofing of a farm is an indication that the farmer has learned the necessity of stopping all small leaks, which mean reduced profits.

A rat-proof farm is not necessarily one in which the entire farmstead is absolutely proofed, but rather one where conditions are so unfavorable for any invading rats that they either will desert the premises of their own accord or may be easily routed by man or dogs. The source of the trouble on almost any heavily rat-infested farm can be traced directly to conditions that furnish rats safe refuges near abundant food. The commoner of these rat-breeding places are beneath wooden floors set a few inches off the ground in poultry houses, barns, stables, granaries, corncrubs, and even residences; in piles of fuel wood, lumber, and refuse; in straw, hay, and manure piles that remain undisturbed for long periods beneath concrete floors without curtain walls; and inside double walls of buildings. In rat proofing the farmstead as a whole, attention should first be paid to the premises outside the buildings and later to each building separately.

Neatness is of prime importance in keeping a place free from rats, and providing facilities for keeping it neat should be considered part of the rat-proofing program. An incinerator, which can be made from a discarded metal drum or rolled-up poultry netting, is convenient for burning all trash and combustible waste; and a deep, covered pit with a trapdoor will take care of tin cans and other noncombustibles, if it is not practicable to haul them away at regular intervals. A covered

garbage can is also indispensable on farms where table scraps are not fed directly to poultry or hogs. (Fig. 1.) Raised platforms, 18 or more inches high, should be provided upon which to pile lumber or other materials that if placed on the ground would afford shelter for rats. (Fig. 2.)



B31216

FIGURE 1.—An automatic garbage can, always closed

Large piles of cut stove wood on many northern farms become rat infested. The same is true of manure piles adjoining barns and, to a lesser extent, of hay and straw stacks near farm buildings. These do not provide food and are attractive to rats for harbors only if near a source of food supply; moving them to a place at some distance from where foodstuffs are handled will usually solve the problem.

Stone walls at times furnish excellent harborage for rats but, like the woodpile, only if there is ample food near by. Stone walls supporting embankments and driveways on sloping farmsteads are most frequently infested, and when this occurs the inviting openings can usually be readily closed with small stones and cement.

Ditch banks often are a source of rat infestation, but in most climates during the warmer months only. The rodents concentrate in such places because they are less likely to be disturbed there. Rat proofing the ditch bank consists merely of burning or otherwise destroying the protective vegetation. This, of course, affords only temporary relief and should not be considered strictly rat proofing.

The use of concrete in the construction of most farm buildings is usually the best means of permanently excluding the rat. Fortunately, many of the fundamentals of rat proofing are also principles of good construction. As an example, in order to support a building properly, the foundation should extend well into the ground below the frost line; rat proofing likewise requires that the foundation wall extend at least 2 feet below the surface. Rats seldom burrow deeper than 2 feet unless natural passageways assist. Foundation walls should project a foot or more above the ground in order to protect the wooden parts of the building, and this also lessens the opportunity for rats to gnaw through the wall. A rat is not likely to cling to the exposed exterior of a building a foot above the ground while it gnaws a hole through wooden sheathing or siding. It would do so very quickly, however, if such siding extended to the ground, where its work could be under cover of vegetation or behind some object, particularly when the siding becomes somewhat rotted, as would soon happen were it close to the ground.

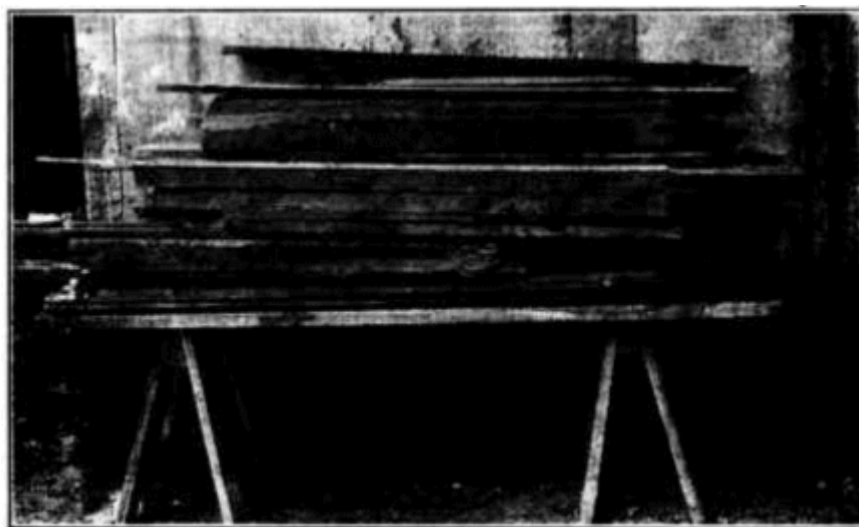

B3139M

FIGURE 2.—Lumber and other stored materials piled well off the ground to prevent rat harborage

It is important that concrete be hard, as weak concrete is but a slight obstacle to the sharp rodent incisors. The mixture approved for ordinary building construction, however, is sufficiently hard to be entirely rat proof, and it is essential that approved practices of mixing and placing concrete be followed. Directions for using concrete and for building

concrete floors are given in Farmers' Bulletin 1279, Plain Concrete for Farm Use, and in Farmers' Bulletin 1480, Small Concrete Construction on the Farm. Other approved building practices, such as fire stopping double walls, eliminating waste dead spaces, making doors, windows, and ventilators fit tightly, and screening or permanently stopping all openings, are also necessary in rat proofing. For simple farm buildings the foundation illustrated in [Figure 3](#) meets all the requirements of good construction and will keep the rats out if the walls are tight.

## BARNs

It is seldom possible to shut out rats completely from barns or entirely to cut off their food supply where livestock is fed. Little trouble will be experienced with them, however, if their harbors are eliminated. In barns rat harbors are most frequently found around stalls, under wooden mangers, and stall partitions, and beneath wooden or dirt floors. In modern barns with concrete floors, concrete or metal mangers, and metal stanchions, such places of retreat are entirely eliminated. In older barns it is desirable at least to replace wooden and dirt floors with concrete and reconstruct the mangers so that they are a foot or more off the ground.

Another common source of rat trouble, particularly in the northern half of the United States, is the hollow wall, within which rats find safe retreat and convenient runways leading to the haymow. In recent years fibrous insulating materials have been used to line the interiors of many farm buildings, and in most cases these have resulted in greatly increased rat infestation. Rats cut through these composition boards very easily and seem to be attracted by the facilities for breeding thus provided. Hollow walls of any kind accessible to rats should either be eliminated or adequately rat proofed. Such rat proofing may be accomplished by filling the hollow spaces to a height of 8 or 10 inches above the sill with cement, bricks, or other material resistant to the gnawing of rats, or a strip of galvanized metal 2 or more feet wide may be carried around the inside wall just above the sill.

Old barns with wooden floors supported a few inches above the ground on girders and posts are particularly objectionable from the standpoint of rat infestation and should be rat proofed with concrete. (Fig. 4.) A concrete foundation wall extending at least 2 feet below grade is placed under the girder between the posts. The wooden posts may be removed after the wall has hardened, and the spaces left should then be filled in with concrete. A concrete floor is laid, and cement stucco on metal lath is extended up the walls for at least 2 feet, preferably to the level of window sills.

Rock foundations in many old barns offer excellent harborage for rats unless pointed carefully with cement mortar. If possible, the floor should be raised to the level of the sill and the walls plastered to the window-sill level (fig. 5) in such manner as to prevent access by rats to spaces between the studs.

The grain bin and other similar fixtures must always be considered in rat proofing a barn. It is most important that they be so situated or constructed that there shall be no hiding places for rats behind or under them. The grain bin should be completely lined or covered with metal and should have metal-clad lids. Any open spaces behind or under the bins should be tightly closed with metal. (Fig. 6.)

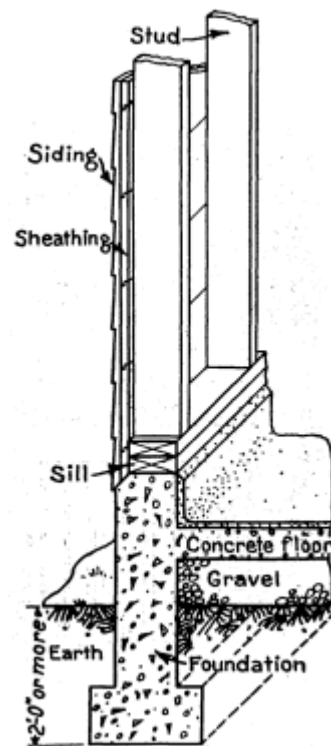

FIGURE 3.—Foundation and floor suitable for most types of farm buildings

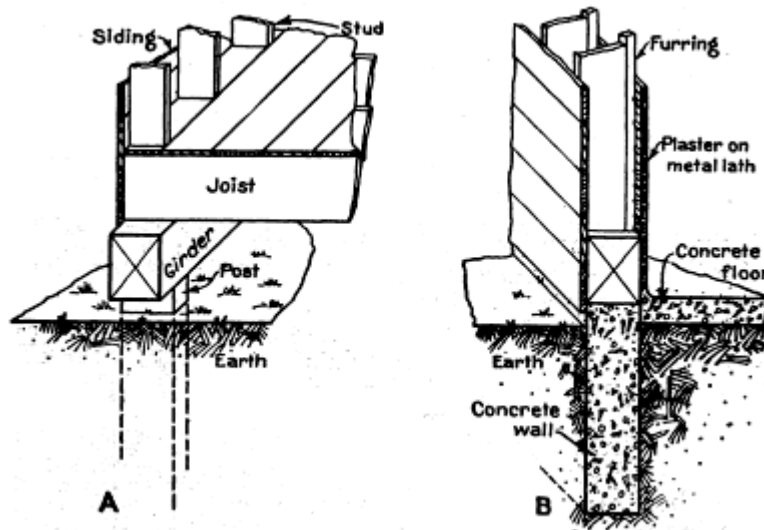

FIGURE 4.—A, Detail of old barn with floor supported a few inches above ground on girders and posts; B, same barn made rat proof with concrete foundation and floors and cement-plastered walls

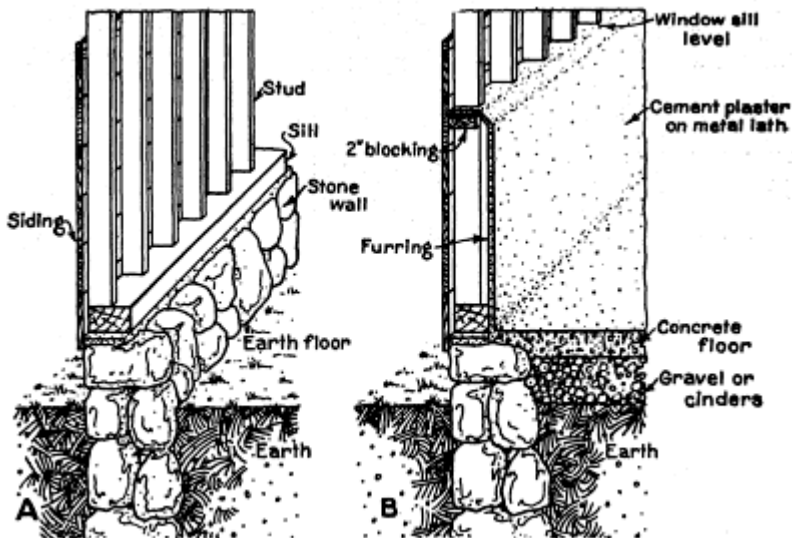

FIGURE 5.—Method of rat proofing old stable, A. Concreting and plastering as shown in B makes for better sanitary conditions behind stock

Other accessories of various kinds of barns should be examined carefully and remodeled or moved if necessary to exclude rats or eliminate harbors. The haymow frequently presents a difficult problem in a heavily infested barn, but the haymow alone is seldom responsible for the rats, for if all other rat harbors in the barn are effectively eliminated or shut off, the rats will not long remain with the hay as their only shelter. If the lower walls are of rough surface or composed of open studs covered on the outside, rats can climb at the

corners. They may be prevented from doing so by the application of a strip of metal 8 inches wide placed just below the joists of the upper floor. Recommended construction of walls and floors in new frame barns is shown in [Figure 7](#).

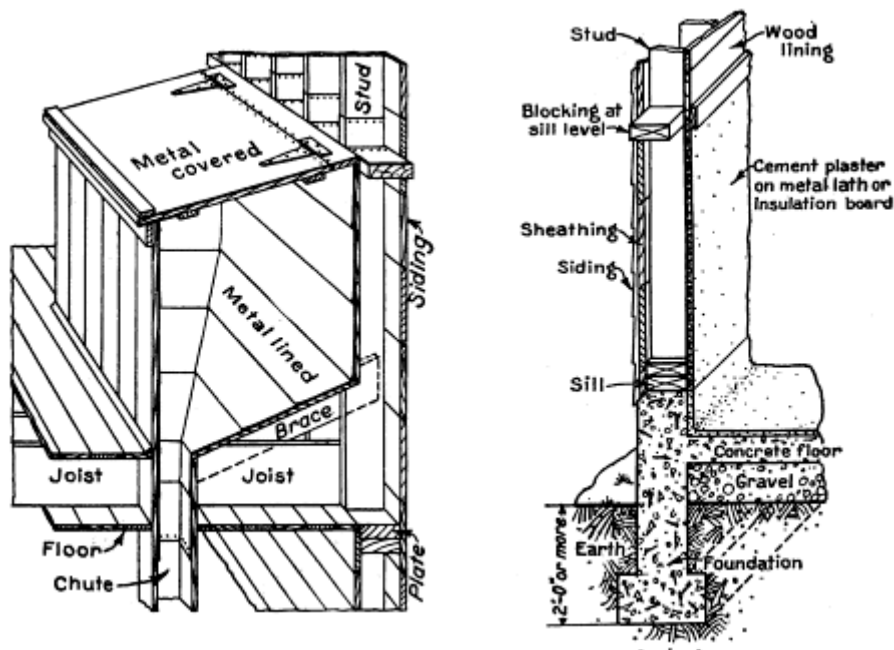

FIGURE 6.—A convenient upper-story rat-proof grain bin

FIGURE 7.—Recommended construction of walls and floors of new frame barns. Cement plaster on metal lath or Insulating board is applied to the inside of the studs at least to the level of the window sills as a better protection against rats and as being more easily kept clean than wooden lining

## CORNCRIBS

Of all the buildings on the average farm the corncrib is usually in greatest need of rat proofing. Losses sometimes amounting to a fourth or a third of the total quantity of corn held over winter have been known. A survey in a southern State showed an average loss of 5 per cent of corn in storage; in one case 500 bushels were destroyed in one crib during one winter. The amount of this loss would have been sufficient to pay for rat proofing the crib several times over. In building or remodeling a corncrib; therefore, it is most important that it be made permanently rat proof. Probably the most satisfactory

method of accomplishing this with the common slat-sided corncrib is entirely to cover the walls and ceiling on the inside and the wooden floors on the under side with woven-wire mesh or hardware cloth, two or three meshes to the inch. A heavy grade of woven wire should be used, 12 or 15 gage, and galvanized after weaving. Painting with a tar or asphaltic paint increases its durability.

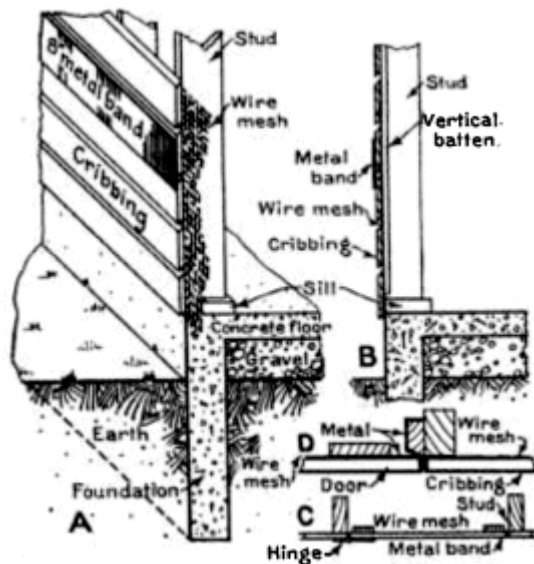
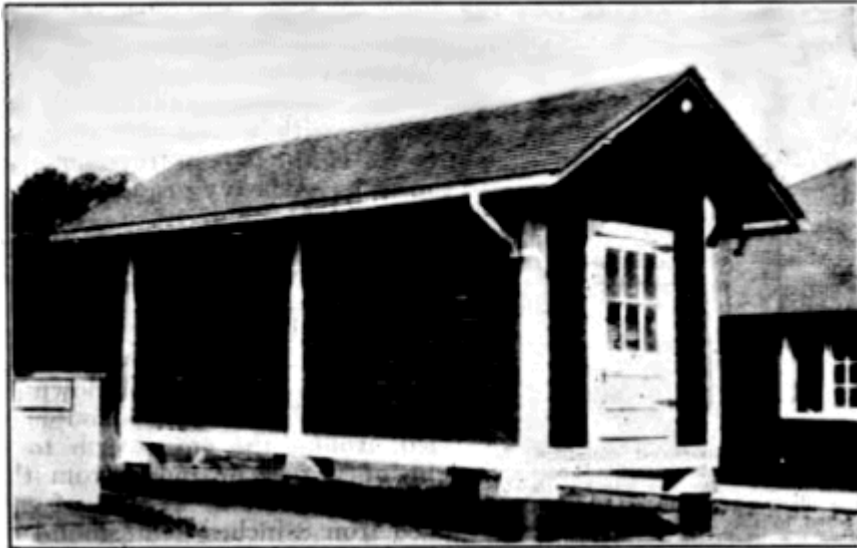

FIGURE 8.—Suggested construction for corncrib: A, Section through wall; B, section through door, which is made of cribbing on vertical battens; the metal band on the wall extends across the door, but is cut and bent inward at the edges of the door; C, plan of door; D, enlarged detail of Jamb at closing side of door

Another method, and one that is less expensive and quite effective as long as kept in good repair, is shown in [Figure 8](#). Wire netting should be carried around the entire crib to a height of 2 feet or more from the top of the foundation. A strip of galvanized iron 8 inches wide should be fastened above the wire netting. The joints between the foundation and netting and between the netting and metal strip must be tight. As rats are unable to gain a footing on the smooth metal and can not climb over it, it is

unnecessary to use wire netting above the strip. Care should be taken to join the lengths of metal tightly and to carry the wire netting and strips of metal across and around both sides of doors and door jambs. It is also advisable to provide doors with springs or weights to insure their remaining closed.



B31365

FIGURE 9.—An inexpensive method of rat proofing a corner crib. It is supported by glazed tiles capped with galvanized washtubs, which, though not attractive in appearance, have successfully kept out rats

If possible the corner crib should have a concrete foundation and floor, as illustrated. Otherwise it should be elevated on posts or piers so that it will have a clearance underneath of feet or more. If the supporting posts or piers are covered with sheet metal, or are protected at the top with metal collars or disks extending at least 9 inches out from the posts, rats will be kept out of the crib. Old cribs can often be rat proofed in this manner at little expense. Dish pans and washtubs make convenient rat guards. (Fig. 9.) It is important that the area beneath the corner crib be kept clear and that nothing that the rats can climb be leaned against it.<sup>[1]</sup>

[1] Plans for a 2,000-bushel corner crib (design No. 521) are available upon request addressed to the Bureau of Public Roads, U. S. Department of Agriculture, Washington, D. C.

## GRANARIES

The rat proofing of granaries is of great importance, because of the abundance of food stored there and the corresponding opportunity for serious loss. The granary with concrete foundation and floors, tight-fitting doors, and screened ventilators presents no unusual problem, except possibly in connection with the elevator pit, which should be carefully checked against possible means of ingress for rats.

Small wooden and portable granaries should be protected with wire netting. ([Fig. 10.](#))

Concrete feeding floors, troughs ([fig. 11](#)), water tanks, hog wallows, and similar structures should be constructed with a curtain wall, or apron, around the outer edge extending 2 feet or more into the ground ([fig. 12](#)) to keep the rats from burrowing underneath the slab. This also tends to prevent the heaving caused by frost and the uneven settling of the structure in soft ground.

## POULTRY HOUSES

It is not practicable to attempt to exclude rats from poultry houses, but such buildings can easily be made proof against serious trouble by the elimination of all places where the rodents can obtain safe harborage. Most rat infestation around poultry plants is due to the presence of numerous shelters and suitable breeding places.

Three things are particularly to be avoided: Wooden floors on or within a few inches of the ground; double walls; and nest boxes, feed hoppers, and other fixtures placed so as to provide shelter for rats under or behind them. From a rat-proofing standpoint the floors as well as the foundation should be made of concrete. ([Fig. 13.](#)) If this is not considered practicable, wooden floors should be elevated so as to insure a clear space of 2 or more feet between the floor and the ground. Warmth can be provided, if necessary, by two thicknesses of flooring with tar paper between. Hollow walls almost invariably furnish harborage for rats. The inner stud covering therefore, should

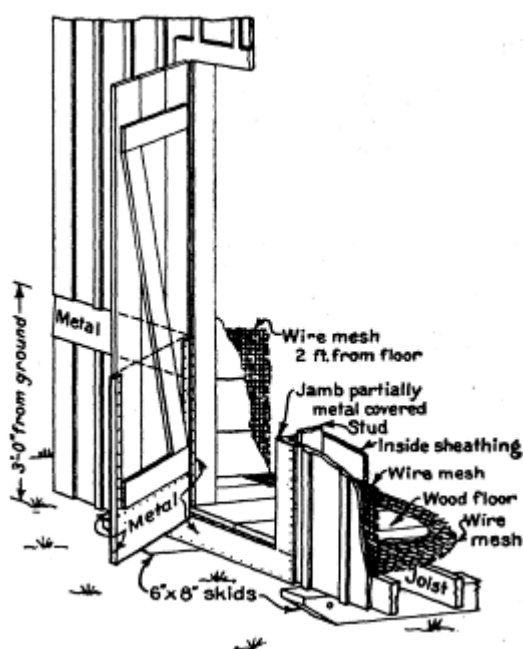

FIGURE 10.—Recommended method of rat proofing a portable granary

be torn out, but if warmth is a factor to be considered, siding should be put over sheathing on the outside of the studs with building paper between. [2]

[2] The construction of poultry houses and fixtures is described in Farmers' Bulletin 1554, Poultry Houses and Fixtures.



B4390M

FIGURE 11.—Rat proof pigpens and feeding troughs are easy to keep clean and sanitary, and rats have little opportunity to steal the feed

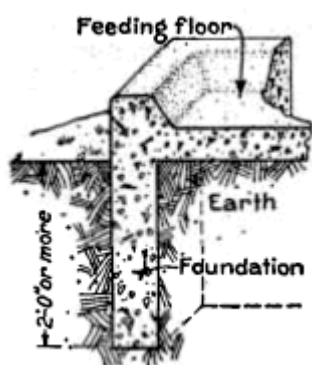

FIGURE 12.—A concrete curtain wall or apron under a feeding floor prevents raveling of earth and consequent breaking of the slab, as well as the harboring of rats

Portable laying and brooder houses frequently become heavily infested because they are usually built with wooden floors removed from the ground only by the height of the runners on which they are constructed and are seldom moved as frequently as originally intended. Feed, sifting through the floors, attracts rats, which after finding desirable shelter soon establish themselves in burrows beneath the houses and multiply rapidly. Portable houses, therefore, should be raised off the ground 2 or more feet.

Nests should be raised 2 or more feet above the floor, and feed and grit hoppers at least 1 foot.

Drinking vessels for water and skim milk should be supported on a platform 1 to 1½ feet above the floor, so as to eliminate the possibility of rat shelters and keep the liquids in a more sanitary condition. Other equipment should be given the same consideration.

The premises around the poultry house should be cleared of all rat harbors by elevating all objects under which a rat can find shelter. (Fig. 14.) Near-by buildings particularly should be considered, for it is frequently found that rats living exclusively on poultry feed occupy harbors 50 or more feet away from the food source. For this reason it is desirable to build poultry plants at least 100 feet from any possible rat harborage. The vast number of young chicks killed annually by rats would be greatly reduced if these simple precautions were taken.

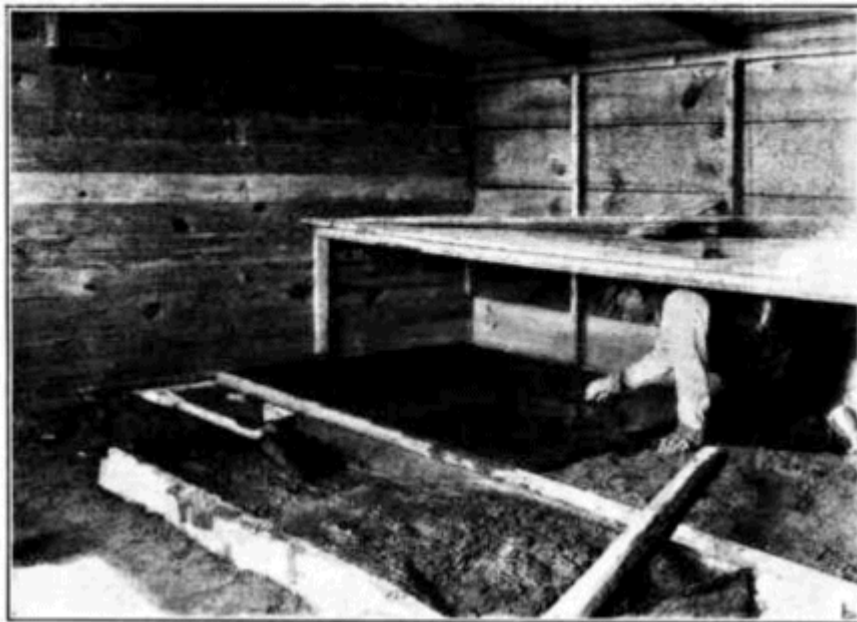

13740C

FIGURE 13.—Rat proofing a poultry house by laying a concrete floor

## OTHER FARM STRUCTURES

There are many farm buildings of various kinds that should be made proof against rats. In most cases, however, the application of the general principles of rat proofing, as previously explained, will suffice. Not only should all buildings in which food is kept be made inaccessible to rats,

but adjoining and near-by buildings and premises as well. The procedure to be followed in the case of farm dwellings is omitted here, as sufficient is included under the next heading, Rat Proofing City Buildings, the conditions with respect to dwellings on farms and in towns being quite similar.

Outside cellars frequently become infested with rats, and great havoc to stored produce almost invariably results. Considerable expense, if necessary, is justified in making the storage cellar rat proof. A cellarway with wooden steps and sills and earth floor is usually the source of the trouble. The sill soon rots or the rats burrow under it to gain entrance. The remedy is to construct a concrete floor and cellarway. This not only will exclude rats but will prove more economical in the long run. ([Fig. 15.](#))



7651-C

FIGURE 14.—Coop built up off the ground, rather than with the floor resting on the ground and thereby affording rats a desirable hiding place.

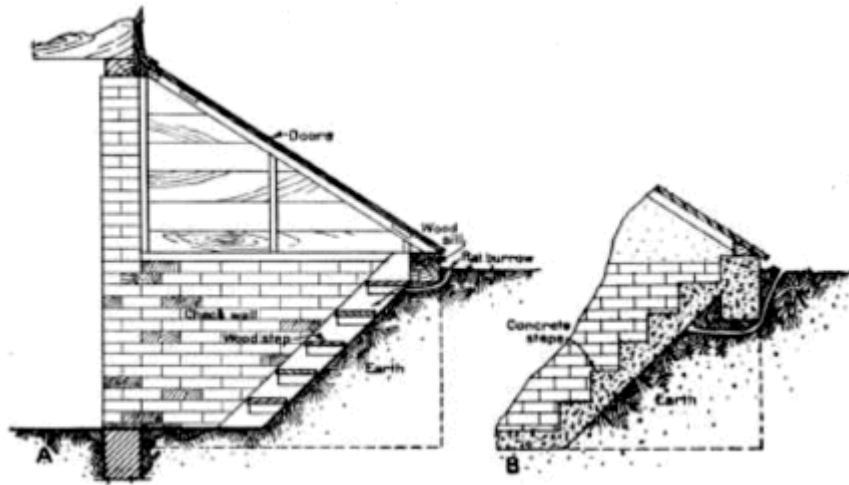

FIGURE 15.—A, Cellarway before rat proofing; B, cellarway rat proofed

[Click on image to view larger sized.](#)

---

## RAT PROOFING CITY BUILDINGS

In rat proofing a city building it is well first to look to the exterior. If the locality is heavily infested with rats, some are almost certain sooner or later to find their way into the building however well protected against them it may be. Garbage and trash usually comprise the bulk of the rats' food supply. A metal, water-tight garbage can, large enough to contain all garbage accumulations between collections and having a close-fitting lid (fig 1), is of prime importance and should be required in all cases by city law.



B2008M

FIGURE 16.—An accumulation of trash such as this is almost certain to attract rats and should be prohibited by law

Large accumulations of trash usually, contain much waste food ([fig. 16](#)) and are certain to attract rats and furnish an ideal breeding place for them. Furthermore, they are a menace to health and should not be tolerated under any circumstances. All other rat harbors, such as wooden floors and sidewalks very near the ground, should be removed or replaced with concrete, and piles of lumber and various materials stored out of doors should be removed or elevated 18 or more inches. Particular care should be taken to see that sheds and other

outbuildings, porches, steps, loading platforms, and similar structures on the premises are made rat proof, either by the use of concrete, by elevation, or by keeping them open to the light and easily accessible.

A thorough inspection should next be made of the building itself and careful note taken of alterations and repairs necessary for a thorough job of rat proofing. Inspection should begin in the basement. Doors and windows should fit snugly, particularly doors leading to outside stairs or elevators, and these should also be provided with automatic closing devices. Windows and ventilators should be screened or covered with gratings, the openings not more than half an inch square. Defects in basement floors should be repaired with concrete, and floor drains should be fitted with tight covers, ([Fig. 17.](#))

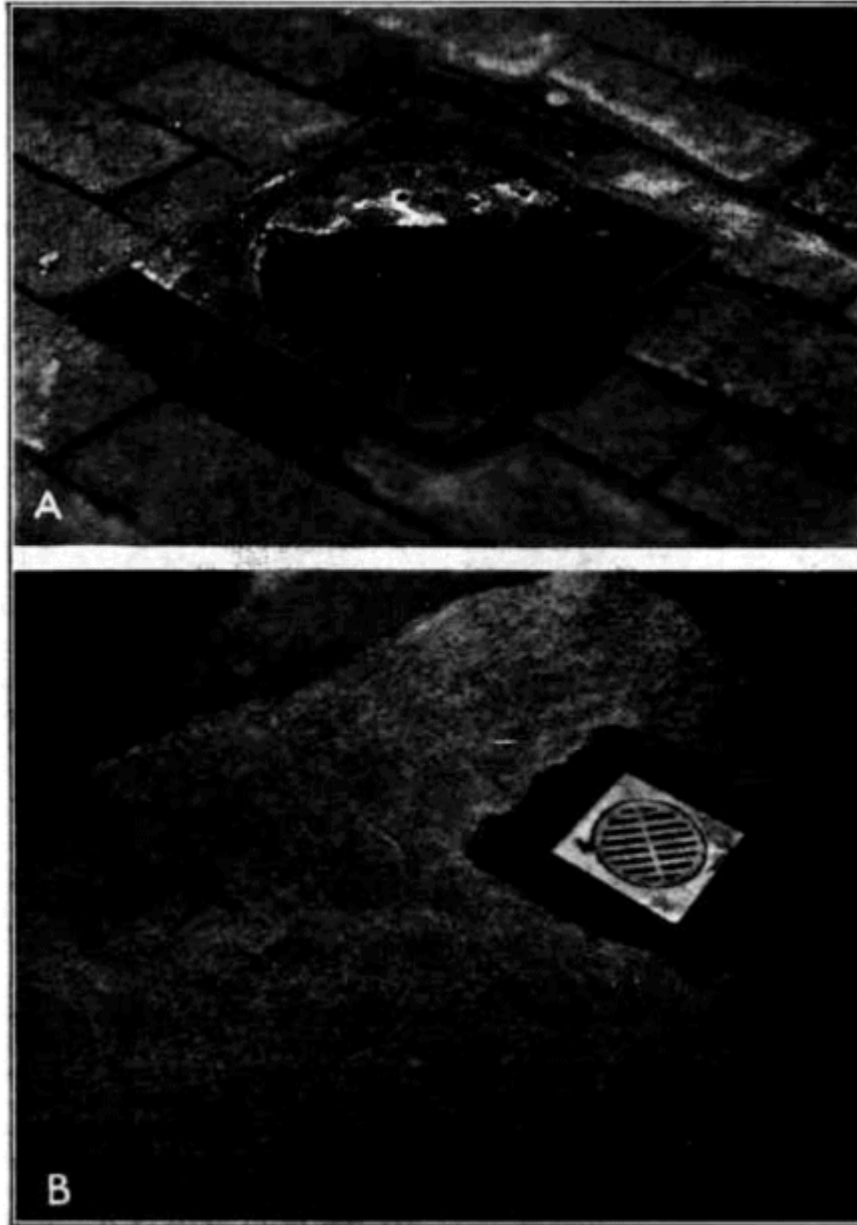

B3341M:B3331M

FIGURE 17.—A, Broken floor drains provide a ready means for invasion by rats; B, rat tracks in freshly laid concrete around newly repaired drain show that before repairs were made the drain was a rat highway

Side walls should be carefully inspected, and all openings made for plumbing ([fig. 18](#)), electric-wire conduits, areas around windows and doors, and unpointed joints in masonry walls (frequently left when the exterior of the wall is hidden from public view by porches or platforms) should be carefully closed with cement mortar. ([Fig. 19.](#))

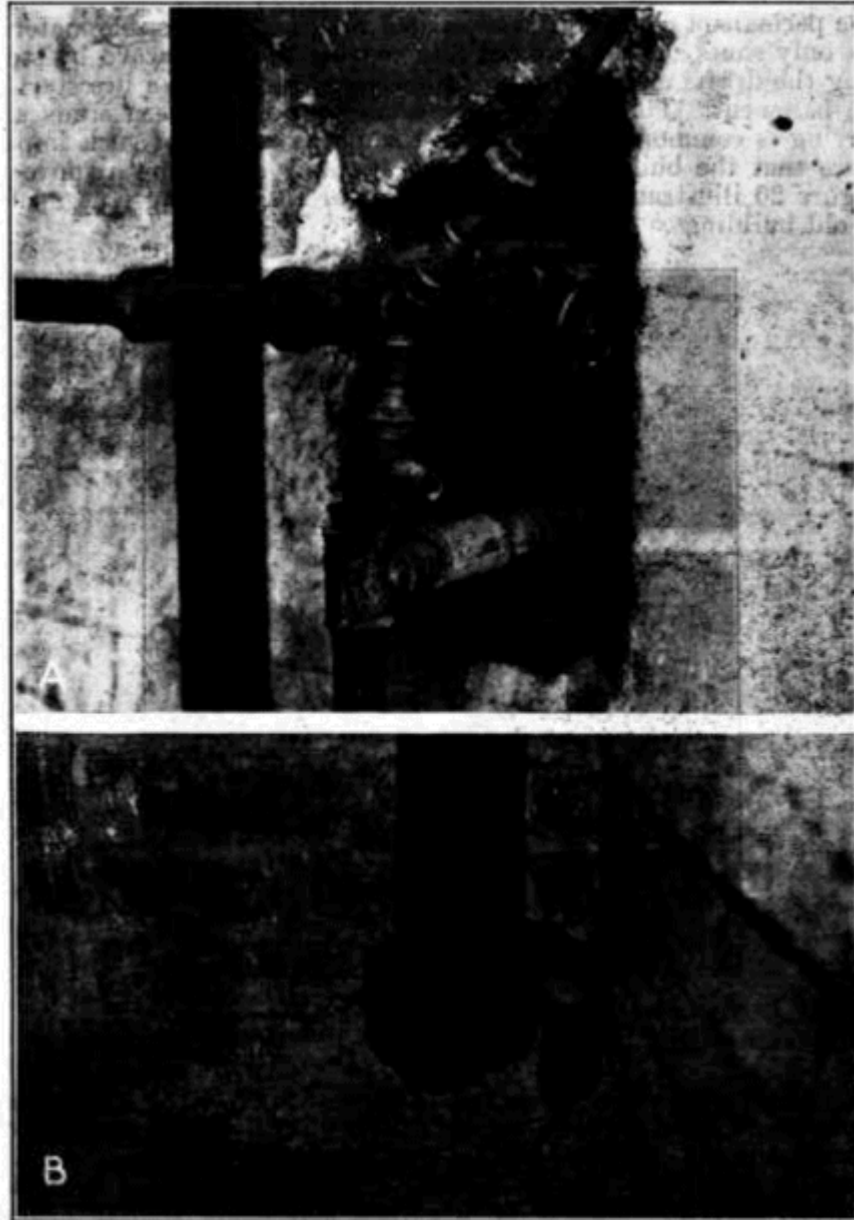

B28391:B4391M

FIGURE 18.—A, Openings around pipes are a common source of rat infestation; B, situations like this give rats access to otherwise rat-proof buildings

Basement ceilings, when accessible to rats, cause much trouble, and frequently the best remedy is to remove them entirely. In frame construction spaces between studs in walls opening into basements also are a common cause of rat infestation of the whole building. The permanent closing of these spaces with noncombustible material not only shuts out the rats but also reduces the fire hazard by stopping the drafts and the rising of heated gases should a fire start in the basement. This process of blocking spaces between studs and

furring is commonly known as fire stopping and is of such importance that the building regulations of many cities now require it. [Figure 20](#) illustrates practical methods of rat proofing stud spaces in old buildings.



B4388M

FIGURE 19.—Defects in foundations, such as the opening to the right of the step, are often the cause of rat infestation in old buildings

All openings between floors and in partitions made for the passage of pipes and wires and any defects in the wall should be closed with metal flashing. All dead spaces throughout the building, such as boxed-in plumbing, spaces behind or beneath built-in cabinets, counters, shelving, bins, show windows, and many similar places, should be removed, opened up, or effectively and permanently proofed against rats.

In the Southern States, where the roof rat occurs, similar care must be taken to make the upper floors and roofs of buildings rat proof, as this rat is an expert climber and frequently enters buildings by way of the roof. Doors at the top of stairs and elevators should fit snugly, and all ventilators, exhaust fans, unused chimney flues, and other openings should be screened. Broken skylights and openings under eaves and

places where electric wires enter the building should be repaired or closed.

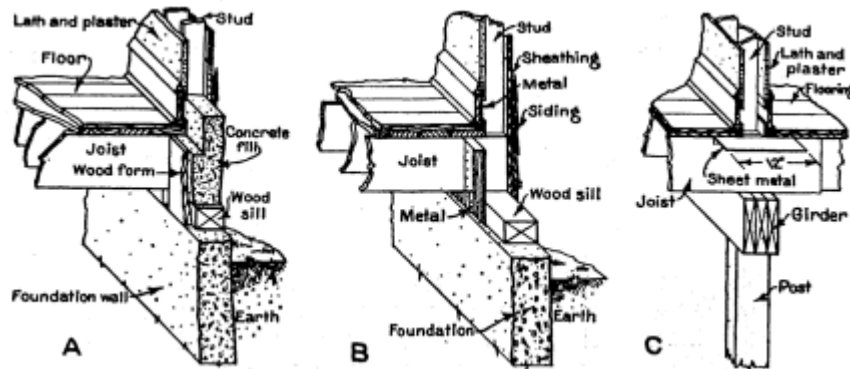

FIGURE 20.—Methods of rat proofing stud spaces in old buildings: A, Construction at outer wall. Open stud spaces are filled with weak concrete, which is placed by removing the skirting above. If the work is done a little at a time, the wooden forms can be removed when the concrete has set, and used again. B, Another method employing sheet metal secured to sill, joist, and flooring. C, Post and girder in basement supporting partition with open stud spaces. Sheet metal nailed to joists and floor and fitted about the stud prevents access to upper floors

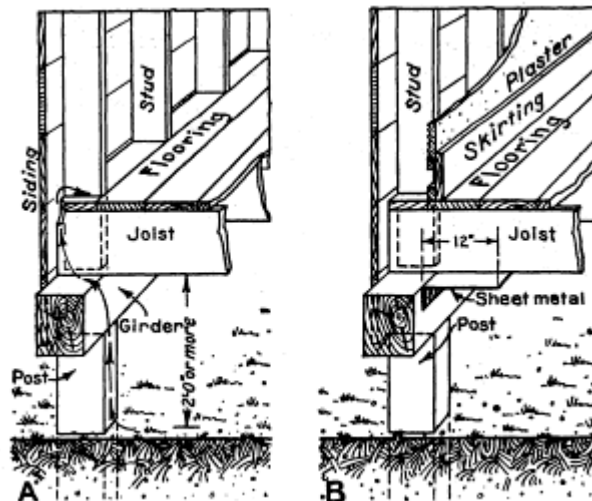

FIGURE 21.—A, Typical construction of frame building on wooden girders and posts with Joists more than 2 feet above ground; B, sheet metal placed as shown serves to prevent the rats from climbing to a point where they can gnaw through the wood

Buildings that have neither basements nor continuous masonry foundations present more difficult rat-proofing problems. The most effective procedure is to construct a concrete foundation wall between the existing supports and, after the wall has hardened, remove the supports, if of wood,

and replace them with concrete to make the wall continuous. Where the cost prohibits following this plan and where the supporting sill and joists are at least 2 feet above the ground level, satisfactory rat proofing may be attained by stopping the spaces between the studs with weak concrete or other material resistant to rats for a distance of 8 inches above the floor level, or with galvanized-metal flashing nailed to the joists, plate, and floor. (Fig. 21.) The space beneath the building must be free from all rubbish and other material that would afford shelter for rats. A continuous masonry foundation, with screened openings to provide ventilation, presents a more pleasing appearance.

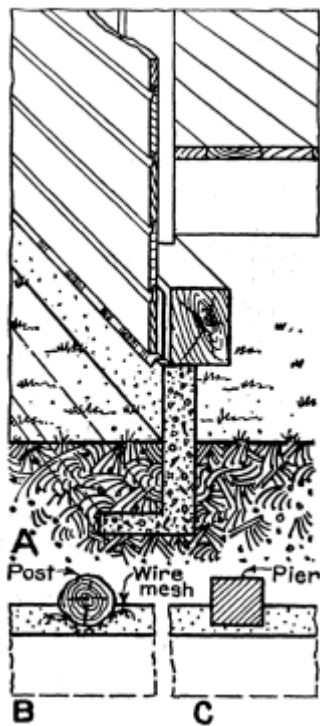

FIGURE 22.—A, Concrete curtain, or area wall, designed for rat-proofing purposes; it does not support the building. B, Plan of wall where supports are of wood; the concrete is bound to the posts with wire mesh. C, Plan of masonry support; concrete will adhere to

If the clearance between the ground level and the bottom of girders and joists is less than 2 feet, it may provide a hazardous rat harbor. One of three things should be done: The building should be elevated on piers 2 feet above the ground; a concrete foundation should be built as described above; or a continuous concrete curtain wall should be constructed under the entire outer wall of the building. (Fig. 22.)

Most new city buildings are now built practically rat proof, or could be made so with only minor changes in the plans and at small cost. Yet if certain essential details are not included at the start, endless rat troubles are likely to ensue. It is therefore highly desirable that plans for every new building include specifications for rat proofing.

All new buildings in which foodstuffs are to be handled should have ground floors of concrete or other rat-proof material and concrete or

the masonry if the surface is roughened masonry walls extending at least 2 feet below and 1 foot above the ground surface. All unnecessary openings in the foundation, walls, and floors should be permanently closed, and windows and ventilators should be screened. Stud spaces in frame construction should be stopped with noncombustible material resistant to rats. New buildings in which foodstuffs are not to be handled may, if desired, be elevated on piers or posts to provide a clearance of 2 feet between the ground level and the bottom of the supporting girders, although the concrete or masonry wall is more satisfactory.

## MARKETS

Public, farmers', and wholesale markets, commission houses, and similar places where vast quantities of foodstuffs are assembled and redistributed are nearly always infested with large numbers of rats. Such structures are usually concentrated in districts, and these often become rat-breeding centers, from which the rats constantly overflow to adjoining sections of the city. Rat proofing a district of this kind would seem to be almost hopeless, yet it has often been demonstrated that the task is not only feasible but entirely practicable. Here, more than anywhere else, the great need is the elimination of rat shelters, which in turn means the free use of concrete or other masonry. Scrupulous cleanliness is essential in markets, but even where this is practiced it is not possible completely to eliminate rat food, so the main reliance must be placed on the removal of all rat harbors. Not only must the building in which the market is housed be rat proofed, but also all the fixtures. In old public markets the stalls were frequently constructed as if designed for the protection of rats. Dark, out-of-the-way holes under counters, stands, and shelves afford convenient places for the accumulation of trash, which it would be well to destroy; and in such locations, with abundance of food at hand, rats are in the best possible position to thrive and multiply. The use of smooth concrete or tile counters ([fig. 23](#)) erected on concrete floors deprive rats of the essential shelter, provided that the space underneath the

counter is kept clean and that stored material is moved frequently. The smooth surface also prevents the rats from climbing and makes it possible to leave edible products on the counter overnight without fear of their being damaged or contaminated by the rodents. If wooden floors are used, the boards should be laid flat on the concrete or on sleepers not more than half an inch high.



B3137BM

FIGURE 23.—Rat proof market stalls. Rats are unable to climb the smooth tiles to get at foodstuffs left on the counter

## WAREHOUSES

Warehouses require rat proofing because of the great quantities of foodstuffs handled there and even stored for long periods. It is essential that the building itself be rat proofed with concrete or masonry foundation, concrete floors, and tight-fitting doors lined with metal at the base. Doors of warehouses frequently become jammed as a result of heavy trucking and should be carefully watched for defects that would admit rats. Concrete floors, in addition to being rat proof and fire proof, save labor because of the comparative ease with which loaded trucks can be rolled over them.

When warehouses are found to be seriously infested with rats, the trouble can usually be traced to such faulty

construction as allows the rats access to spaces beneath floors or within walls, or even provides exits to near-by shelter outside.

Eats also gain entrance to rat-proofed warehouses through being shipped in with produce or when doors are left open, and once inside they may persist and do much damage from shelter afforded by piles of stored goods. Such damage, however, is usually small in comparison with that resulting from permanent rat harbors beneath floors, and the rats can be destroyed much more easily. A report from one flour warehouse indicated that it cost more than \$3,000 a year to repair bags gnawed by rats and mice. Such a loss would go far toward rat proofing any premises. A common cause of rat depredations in warehouses is the construction of platforms a few inches off the floor upon which to pile flour and other produce. Such platforms provide permanent shelter for rats and should be eliminated. Boards may be laid flat on the concrete floor with no spaces between them to afford rat harbors; or, if this is not sufficient proof against dampness, the platforms should be raised a foot or more off the floor to admit light. In such a place a rat does not feel safe and will not stay. Bags of flour, grain, and other produce furnish harborage that can not well be avoided, but such goods are usually moved so frequently that rats do not have opportunity to

---

## RAT PROOFING THE CITY

Rat proofing the city is a responsibility of the city government. The greatest force that can be exerted to-day toward the permanent suppression of the rat pest is through the passage of practical building ordinances that require the rat proofing of buildings and the adoption of sanitary regulations that will insure clean premises and adequate collection and disposed of garbage. It has been demonstrated that such requirements not only are effective in reducing the numbers of rats to the minimum, but also that they greatly improve health conditions, reduce the fire hazard, and from a purely economic standpoint are profitable. In one city in which rat proofing has been vigorously prosecuted for a number of years and in which more than 80 per cent of the old buildings have been made proof against rats, the sharp decline in the number of fires resulted in a 5 per cent reduction in the fire-insurance rates. More than \$1,000,000 was spent in the same city in rat proofing 10 miles of docks, but even this large expenditure was found to be a profitable investment.

Probably nothing so nearly reflects the sanitary conditions of a city as the number of rats that it harbors, for the rat population is usually in inverse ratio to the degree of sanitation maintained. In 1930 at least 13 cities in this country had rat-proofing laws, and more than 30 others had fire-stopping requirements that are important in rat proofing.

An effective rat-proofing program must be practicable and not too drastic; otherwise it will fail from lack of popular support. Attempts to enforce rat proofing of existing structures would probably not be feasible unless under stress of an outbreak of bubonic plague or other rat-borne disease epidemic. There seems to be no good reason, however, why buildings constructed in the future or remodeled should not be made rat proof under the requirements of building ordinances. Had such ordinances been enacted 50 years ago and rigidly enforced since that time the large majority of buildings to-day

would be rat proof, and rats, with their accompanying filth and destructiveness, would have been largely eliminated. There would also be fewer of the unsightly and insanitary shacks now existing in most cities, and the average structure would be of a more desirable type. As modern construction conforms so closely in principle to the requirements of rat proofing, there should be little, if any, opposition among builders to a rat-proofing clause in building ordinances.

In considering the suppression of rats, at the outset city authorities should discard all methods other than those that strike at the source of the trouble. The actual destruction of rats is necessary as a temporary means of stopping their depredations, but modern construction and sanitation are the weapons that must be relied upon to gain permanent relief. In addition to a rat-proofing ordinance, every city should have a law requiring that all garbage wherever accumulated be kept in rat-proof containers or garbage cans until collected or until destroyed by incineration or otherwise disposed of in a manner that would avoid the possibility of its providing food for rats. Containers should have covers not easily removed by dogs and other animals. The city should also enact regulations prohibiting the accumulation of trash, refuse, or waste matter of any kind on either public or private premises, and should provide adequate means for collecting and disposing of all waste.

Consideration should also be given to the sewer system. Although most modern sewers do not offer opportunity for the unrestricted breeding of rats, there are many still in use that furnish harbors for large numbers of these pests in sections of some cities. Of most importance is the corner catch basin, storm sewer, or street-drainage opening, which should be effectively remodeled, if necessary, to provide smooth interior vertical walls with a drop of at least 3 feet; rats are unable to jump 3 feet vertically or to climb smooth surfaces.

Another place that should receive attention is the city dumping ground, which frequently serves as an incubator for rats, and these soon overflow into near-by sections of the city. A study should be made of methods of disposing of waste

materials and a system put into effect that will meet the requirements of the city and insure the destruction, removal, or adequate covering of all such food for rats. Any other conditions that may be found favorable for the breeding of rats, whether on public or on private property, should be declared a public nuisance and ordered corrected.

## MODEL RAT-PROOFING ORDINANCES

The samples or models of rat-proofing and garbage-removal ordinances here given were prepared by the United States Public Health Service as a result of its experience in combating bubonic plague in several coastal cities. They have, in substance, been adopted and put into practice by a number of cities and have been found practicable. They should be applicable to any city after necessary allowance and possible changes have been made to conform to local conditions and constitutional considerations.

### AN ORDINANCE DEFINING RAT PROOFING OF ALL BUILDINGS<sup>[3]</sup>

[3] U. S. Pub. Health Serv. Bul. 121, Preliminary Report on Proposed Antiplague Measures in Massachusetts.

SECTION 1. *Be it ordained, etc.*, That it shall be unlawful for any person, firm, or corporation hereafter to construct any building, outhouse, or other superstructure, stable, lot, open area, or other premise, sidewalk, street, or alley, or to repair or remodel the same to an extent of \_\_\_\_\_ per cent of cost of construction within the city of \_\_\_\_\_, unless the same shall be rat proofed in the manner hereinafter provided for.

SEC. 2. *Be it further ordained, etc.*, That for the purpose of rat proofing all buildings, outhouses, and other superstructures in the city of \_\_\_\_\_, except stables, shall be divided into two classes, to wit, class A and class B, and the same shall be rat proofed in the manner following, to wit:

*Class A.*—All buildings, outhouses, and other superstructures of class A shall have floors made of rat-proof material or of concrete, which concrete shall be not less than 3 inches thick, and overlaid with a top dressing of cement, mosaic, tiling, or other impermeable material laid in cement mortar, and such floor shall rest without any intervening space between upon the ground or upon filling of clean earth, sand, cinders, broken stone or brick, gravel, or similar material, which filling shall be free from animal or vegetable substances; said floor shall extend and be hermetically sealed to walls surrounding said floor, which walls shall be made of rat-proof material or of concrete, stone, or brick laid in cement or mortar, and each

wall shall be not less than 6 inches thick and shall extend into and below the surface of the surrounding ground at least 2 feet and shall extend not less than 1 foot above the surface of said floor; provided that wooden removable gratings may be laid on such concrete floors in such parts of such buildings, superstructures, and outhouses as are used exclusively as sales departments, provided that wooden flooring may be laid over the concrete wherever the intervening space between such flooring and the concrete shall not exceed one-half inch; provided further that any sleepers that are sunk into the concrete shall be creosoted.

*Class B.*—All accidental and unnecessary spaces and holes, ventilators, and other openings other than doors and windows in every building, outhouse or other superstructure in the city of \_\_\_\_\_, shall be closed with cement, mortar, or other material impervious to rats or screened with wire having not more than one-half inch mesh, as the case may require, and all wall spaces shall be closed with cement, mortar, or other material impervious to rats, which closure shall extend the full thickness of the wall and shall extend upward at least twelve inches above the floor level, and the whole in such manner as to prevent the ingress or egress of rats; or the ingress or egress of rats from such double wall or space may be prevented by protecting the junction of said wall with the floor or other wall with metal flashing of galvanized iron of 28 or 30 gauge, provided that where such double wall is open beneath or is in communication with foundations of the house that said opening shall be effectively closed or said junction with foundations flashed with metal as provided above: *Provided*, That in all buildings, outhouses, and other superstructures of class A and in all stables where there are any spaces in walls between the wall proper and the covering on same, or in ceilings between the ceiling and floor, or other ceiling covering above, said spaces shall be eliminated by the removal of said covering, or so closed with cement, mortar or other material impervious to rats as to prevent the ingress or egress of rats: *Provided*, That all such wall spaces shall be closed with cement, mortar, or other material impervious to rats, which closure shall extend the full thickness of the wall and shall extend upward at least twelve inches above the floor level.

The cellar of every building hereafter erected within the building limits shall be made rat proof by the use of masonry or metal. All openings in foundations, cellars and basements In such buildings, except for doors and hatchways, and except also for such windows wholly above ground as may be exempted by the \_\_\_\_\_ in his discretion, shall be completely covered with screens of metal having meshes of not more than one-half of an inch in least dimension and constructed of rods or wire of not less than twelve gauge.

All buildings, outhouses, and other superstructures of class B separated from any other building on three sides by at least ten feet and lacking any basement or cellar may be rat proofed in the following manner, to wit: Said building, outhouse, or other superstructure shall be set upon pillars or underpinning of concrete, stone, or brick laid in cement mortar, or may be set upon underpinning of substantial timber, such pillars or underpinning to be not less than eighteen inches high, the height to be measured from the ground level to the top of said pillars or underpinning; and the intervening space between said building and the ground level to be open on three sides and to be free from all rubbish and other rat harboring material, or may be made rat proof by constructing at the margin of the ground area of said building a wall of concrete or brick or stone laid in cement; such wall to extend into and below the surface of the ground at least two feet and to meet the floor of the building above closely and without any intervening space, to be at least four inches thick and extend entirely around said building *Provided*, That said walls may be built with openings therein for ventilation only: *And provided further*, That

such openings for ventilation may be all of such size as the owner may elect and shall be securely screened with metallic gratings having openings between the bars of said gratings of not more than one-half inch or with wire mesh of not less than twelve gauge, having openings between the wires of said mesh of not more than one-half inch and the whole so constructed and closed as to prevent the entrance of rats beneath such building.

SEC. 3. *Be it further ordained, etc.*, That every restaurant kitchen, hotel kitchen, cabaret kitchen, dairy, dairy depot, dock, wharf, pier, elevator, store, manufactory, and every other building, outhouse, or superstructure wherein or whereon foodstuffs are stored, kept, handled, sold, held, or offered for sale, manufactured, prepared for market or for sale, except stables, shall be rat proofed in the manner provided for hereinabove as class A: *Provided*, That such part of any structure hereinabove defined as of class A that shall be entirely over a body of water may be rat proofed as of class B, as hereinafter provided for.

"Foodstuffs," as used in this ordinance, is hereby defined to be flour and flour products, animals and animal products, produce, groceries, cereals, grain, and the products of cereals and grain, poultry and its products, game, birds, fish, vegetables, fruit, milk, cream, and products from milk or cream, ice cream, hides, and tallow, or any combination of any one or more of the foregoing.

All other buildings, outhouses, and superstructures, except stables, not hereinbefore specified as class A, and all buildings used exclusively for residential purposes, shall be rat proofed in the manner provided for hereinabove as class B: *Provided*, That the owner of any building, residence, outhouse, or other superstructure in class B may, if he so elects, rat proof same in the manner provided for in class A.

*Provided*, That in any case where, under the foregoing provisions, any building, outhouse, or superstructure is required to be rat proofed as of class A and the said building or outhouse or superstructure is used in part for residential purposes, and the part used as a residence is effectively separated from the part falling within class A, by permanently and effectively closing all openings above and below the ground floor, or by constructing a new wall, and in either case the whole in such manner as to make such wall whole and continuous in its entirety, without doorways, windows, or other openings between the part used as a residence and that used for such purposes as makes it fall within class A, then in such case and for rat-proofing purposes only, the said building will, after such separation and closure of the openings, or by the construction of such new wall, be deemed to be two buildings; and that part used exclusively for residential purposes may be rat proofed in the manner provided for as a class B building, and the remaining part of said building shall be rat proofed in the manner provided for a class A building.

*Stables.*—Stables and all buildings hereafter to be constructed and used for stabling horses, mules, cows, and other animals shall be constructed as follows:

**Walls:** The walls of such buildings shall be constructed of concrete, brick, or stone, laid in cement mortar, and shall be not less than four inches thick, and shall extend into and below the surface of the surrounding ground not less than two feet, and shall extend above the ground sufficient height as to be not less than one foot above the floor level. All openings in such foundation walls shall be covered with metal grating having openings not greater than one-half inch between the gratings.

**Floors:** The floors of stables and stalls shall be of concrete not less than three inches thick, upon which shall be laid a dressing not less than one-half inch thick of cement or stone, laid in cement mortar, or shall be constructed of floated concrete

not less than four inches thick, in such way as to prevent ingress or egress of rats, and such floors to have a slope of one-eighth inch per foot to the gutter drain hereinafter provided for.

Stalls: The floors of stalls may be of planking, fitting either tightly to the concrete floor or elevated not more than one-half inch from the stall floor, and so constructed as to be easily removable. Such removable planking shall be raised at least once a week, and the said planking and the concrete floor beneath thoroughly cleansed.

Gutters: Semicircular or V-shaped gutters shall be constructed in such manner that a gutter shall be placed so as to receive all liquid matter from each stall, and each of these gutters to connect with the public sewer or with a main gutter of the same construction, which in turn shall be connected with the public sewer or public drain. All openings from drains into sewers shall be protected by a metal grating having openings not more than one-half inch between the gratings.

Mangers: Each manger shall be constructed so as to have a slope of two inches toward the bottom, shall be covered with tin or zinc, and shall be at least eighteen inches deep, to avoid spilling of food.

Feed bins: All feed bins shall be constructed of cement, stone, metal, or wood, and with close-fitting doors. If constructed of wood, the bins shall be lined or covered with metal, and the whole so constructed as to prevent the ingress or egress of rats. All grain, malt, and other animal food, except hay, stored or kept in any stable, must be kept in such feed bins. Said feed bins must be kept closed at all times, except when momentarily opened, to take food therefrom or when same are being filled. No feed shall be scattered about such bin or stable, and all such feed found on the floor or in the stalls of said stables shall be removed daily and placed in the manure pits. No foodstuffs intended for or susceptible of human consumption shall be kept or stored in any stable or any other place where animals are kept.

SEC. 4. *Be it further ordained, etc.*, That the construction and materials used in rat proofing shall conform to the building ordinances of the city of \_\_\_\_\_, except and only in so far as the same may be modified herein.

SEC. 5. *Be it further ordained, etc.*, That all premises, improved and unimproved, and all open lots, areas, streets, sidewalks, and alleys in the city of \_\_\_\_\_ shall be kept clean and free from all rubbish and similar loose material that might serve as a harborage for rats; and all lumber, boxes, barrels, loose iron, and similar material that may be permitted to remain thereon and that may be used as a harborage by rats shall be placed on supports and elevated not less than two feet from the ground, with a clear intervening space beneath, to prevent the harboring of rats.

SEC. 6. *Be it further ordained, etc.*, That all planking and plank walks on and in yards, alleys, alleyways, streets, sidewalks, or other open areas shall be removed and replaced with concrete, brick, or stone, laid in cement, gravel, or cinders, or the ground left bare.

SEC. 7. *Be it further ordained, etc.*, That it shall be the duty of every owner, agent, and occupant of each building, outhouse, and other superstructure, stable, lot, open area, and other premises, sidewalk, street, and alley in the city of \_\_\_\_\_ to comply with all the provisions of this ordinance.

SEC. 8. *Be it further ordained, etc.*, That it is hereby made the duty of \_\_\_\_\_, and particularly through its health department, to enforce the provisions of this

ordinance.

SEC. 9. *Be it further ordained, etc.*, That any law or ordinance in conflict with the provisions of this ordinance be, and the same is hereby, repealed.

---

## AN ORDINANCE REGULATING THE REMOVAL OF GARBAGE

SECTION 1. *Be it ordained* \_\_\_\_\_ *of the city of* \_\_\_\_\_, That from and after the promulgation of this ordinance, the owner, agent, and occupant of every premise, improved or unimproved, in the city of \_\_\_\_\_, whereon or wherein garbage shall be created, shall provide a metal, water-tight container or containers, each with a tight-fitting cover, such container or containers to be of such size as to be easily manhandled, and of such number as to receive the garbage accumulation of five days from each such premise, and shall place or cause to be placed such container or containers, for the purpose of having their contents removed, on the sidewalks or open alleys in front or rear of said premises, at the times hereinafter set forth.

SEC. 2. *Be it further ordained, etc.*, That for the purposes of this ordinance, the city of \_\_\_\_\_ is hereby divided into \_\_\_\_\_ garbage districts.

SEC. 3. *Be it further ordained, etc.*, That for the purpose of this ordinance, the word "garbage" as used in this ordinance shall be construed to mean house and kitchen offal, and all refuse matter not excrementitious liquid, and composed of animal or vegetable substances, including dead animals (except cows, horses, mules, and goats) coming from public and private premises of the city, and not destined for consumption as food.

SEC. 4. *Be it further ordained, etc.*, That it shall be unlawful for such owner, agent, or occupant of any such premise to have, maintain, or keep any garbage on any premise except in such garbage containers as are provided for in section 1 of this ordinance.

SEC. 5. *Be it further ordained, etc.*, That such garbage containers shall be kept tightly covered at all times, except when momentarily open to receive the garbage or to have the contents therefrom removed, as provided for hereinafter.

SEC. 6. *Be it further ordained, etc.*, That when such garbage container is placed on the outside of any premise it shall be unlawful for any person engaged in the removal of garbage, or for any person to remove the cover from such garbage container, except for the purpose of emptying its contents into a duly authorized garbage wagon or to throw such garbage container on the street or sidewalk, or to injure it in any way, so as to make it leak or to bend it or its cover, as to prevent said garbage container from being tightly covered; and all persons engaged in the removal of garbage shall, after emptying said container, replace the cover tightly on said container.

SEC. 7. *Be it further ordained, etc.*, That the owner, agent, or occupant of every premise in the city of \_\_\_\_\_ shall keep separate from their garbage and ashes, tin cans, broken crockery, hardware, old planks, wooden matter, paper, sweepings and other trash, and place same in a sound, substantial vessel or container kept for that purpose, which vessel or container shall be placed on the sidewalk or alley in front or rear of each premise of the city of \_\_\_\_\_, as provided in section 1 of

this ordinance, for garbage containers, for removal on \_\_\_\_\_, provided that such rubbish, other than garbage, may be so placed ----- on \_\_\_\_\_.

SEC. 8. *Be it further ordained, etc.*, That the provisions of this ordinance shall apply to all public and private markets, as well as all places of business, hotels, restaurants, and all other premises, whether used for business, boarding, or residential purposes.

SEC. 9. *Be it further ordained, etc.*, That for the purpose of enforcing this ordinance any person living on any premise shall be deemed an occupant, and any person receiving the rent, in whole or in part, of any premise, shall be deemed an agent; that on any premise where construction of any kind is in progress, and where employees or workmen eat their dinners, or lunches, In or about said premises, or scatter lunch or food in or about such premises, the contractor or foreman or other person in charge of such workmen shall be deemed an occupant; and that the person in charge of any market, or stall in any market, shall be deemed an occupant.

SEC. 10. *Be it further ordained, etc.*, That it shall be unlawful for any person to pick from or disturb the contents of any garbage containers or vessels, or other containers provided for in this ordinance.

SEC. 11. *Be it further ordained, etc.*, That each day's violation of any of the provisions of this ordinance shall constitute a separate and distinct offense.

SEC. 12. *Be it further ordained, etc.*, That any person violating any provision of this ordinance shall, on conviction, be punished by a fine of not less than ten (\$10.00) dollars nor more than twenty-five (\$25.00) dollars, or in default of the payment of said fine by imprisonment \_\_\_\_\_ for not less than ten (10) days nor more than thirty (30) days, or both, at the discretion of \_\_\_\_\_ having jurisdiction of the same.

SEC. 13. *Be it further ordained, etc.*, That any law or ordinance in conflict with the provisions of this ordinance, In whole or in part, be and the same is hereby repealed.

## **ORGANIZATION OF THE UNITED STATES DEPARTMENT OF AGRICULTURE WHEN THIS PUBLICATION WAS LAST PRINTED**

<i>Secretary of Agriculture</i>	ARTHUR M. HYDE.
<i>Assistant Secretary</i>	R. W. DUNLAP.
<i>Director of Scientific Work</i>	A. F. WOODS.
<i>Director of Regulatory Work</i>	WALTER G. CAMPBELL.

<i>Director of Extension Work</i>	C. W. WARBURTON.
<i>Director of Personnel and Business Administration</i>	W. W. STOCKBEBGER.
<i>Director of Information</i>	M. S. EISENHOWER.
<i>Solicitor</i>	E. L. MARSHALL.
<i>Weather Bureau</i>	CHARLES F. MARVIN, <i>Chief</i> .
<i>Bureau of Animal Industry</i>	JOHN R. MOHLER, <i>Chief</i> .
<i>Bureau of Dairy Industry</i>	O. B. REED, <i>Chief</i> .
<i>Bureau of Plant Industry</i>	WILLIAM A. TAYLOR, <i>Chief</i> .
<i>Forest Service</i>	R. Y. STUART, <i>Chief</i> .
<i>Bureau of Chemistry and Soils</i>	H. G. KNIGHT, <i>Chief</i> .
<i>Bureau of Entomology</i>	C. L. MARLATT, <i>Chief</i> .
<i>Bureau of Biological Survey</i>	PAUL G. REDINGTON, <i>Chief</i> .
<i>Bureau of Public Roads</i>	THOMAS H. MACDONALD, <i>Chief</i> .
<i>Bureau of Agricultural Economics</i>	NILS A. OLSEN, <i>Chief</i> .
<i>Bureau of Home Economics</i>	LOUISE STANLEY, <i>Chief</i> .
<i>Plant Quarantine and Control Administration</i>	LEE A. STRONG, <i>Chief</i> .
<i>Grain Futures Administration</i>	J. W. T. DUVEL, <i>Chief</i> .
<i>Food and Drug Administration</i>	WALTER G. CAMPBELL, <i>Director of Regulatory Work, in Charge</i> .
<i>Office of Experiment Stations</i>	—————, <i>Chief</i> .
<i>Office of Cooperative Extension Work</i>	C. B. SMITH, <i>Chief</i> .
<i>Library</i>	CLARIBEL R. BARNETT, <i>Librarian</i> .

U. S. GOVERNMENT PRINTING OFFICE: 1930

For sale by the Superintendent of Documents, Washington, D.

C. — Price 5 cents

---

## **Transcriber Notes**

Illustrations were repositioned so as to not split paragraphs.

\*\*\* END OF THE PROJECT GUTENBERG EBOOK RAT  
PROOFING BUILDINGS AND PREMISES \*\*\*

Updated editions will replace the previous one—the old editions will be renamed.

Creating the works from print editions not protected by U.S. copyright law means that no one owns a United States copyright in these works, so the Foundation (and you!) can copy and distribute it in the United States without permission and without paying copyright royalties. Special rules, set forth in the General Terms of Use part of this license, apply to copying and distributing Project Gutenberg™ electronic works to protect the PROJECT GUTENBERG™ concept and trademark. Project Gutenberg is a registered trademark, and may not be used if you charge for an eBook, except by following the terms of the trademark license, including paying royalties for use of the Project Gutenberg trademark. If you do not charge anything for copies of this eBook, complying with the trademark license is very easy. You may use this eBook for nearly any purpose such as creation of derivative works, reports, performances and research. Project Gutenberg eBooks may be modified and printed and given away—you may do practically ANYTHING in the United States with eBooks not protected by U.S. copyright law. Redistribution is subject to the trademark license, especially commercial redistribution.

START: FULL LICENSE

# THE FULL PROJECT GUTENBERG™ LICENSE

PLEASE READ THIS BEFORE YOU DISTRIBUTE OR USE THIS WORK

To protect the Project Gutenberg™ mission of promoting the free distribution of electronic works, by using or distributing this work (or any other work associated in any way with the phrase “Project Gutenberg”), you agree to comply with all the terms of the Full Project Gutenberg License available with this file or online at [www.gutenberg.org/license](http://www.gutenberg.org/license).

## **Section 1. General Terms of Use and Redistributing Project Gutenberg electronic works**

1.A. By reading or using any part of this Project Gutenberg electronic work, you indicate that you have read, understand, agree to and accept all the terms of this license and intellectual property (trademark/copyright) agreement. If you do not agree to abide by all the terms of this agreement, you must cease using and return or destroy all copies of Project Gutenberg electronic works in your possession. If you paid a fee for obtaining a copy of or access to a Project Gutenberg electronic work and you do not agree to be bound by the terms of this agreement, you may obtain a refund from the person or entity to whom you paid the fee as set forth in paragraph 1.E.8.

1.B. “Project Gutenberg” is a registered trademark. It may only be used on or associated in any way with an electronic work by people who agree to be bound by the terms of this agreement. There are a few things that you can do with most Project Gutenberg electronic works even without complying with the full terms of this agreement. See paragraph 1.C below. There are a lot of things you can do with Project Gutenberg electronic works if you follow the terms of this agreement and help preserve free future access to Project Gutenberg electronic works. See paragraph 1.E below.

1.C. The Project Gutenberg Literary Archive Foundation (“the Foundation” or PGLAF), owns a compilation copyright in the collection of Project Gutenberg electronic works. Nearly all the individual works in the collection are in the public domain

in the United States. If an individual work is unprotected by copyright law in the United States and you are located in the United States, we do not claim a right to prevent you from copying, distributing, performing, displaying or creating derivative works based on the work as long as all references to Project Gutenberg are removed. Of course, we hope that you will support the Project Gutenberg mission of promoting free access to electronic works by freely sharing Project Gutenberg works in compliance with the terms of this agreement for keeping the Project Gutenberg name associated with the work. You can easily comply with the terms of this agreement by keeping this work in the same format with its attached full Project Gutenberg License when you share it without charge with others.

1.D. The copyright laws of the place where you are located also govern what you can do with this work. Copyright laws in most countries are in a constant state of change. If you are outside the United States, check the laws of your country in addition to the terms of this agreement before downloading, copying, displaying, performing, distributing or creating derivative works based on this work or any other Project Gutenberg work. The Foundation makes no representations concerning the copyright status of any work in any country other than the United States.

1.E. Unless you have removed all references to Project Gutenberg:

1.E.1. The following sentence, with active links to, or other immediate access to, the full Project Gutenberg License must appear prominently whenever any copy of a Project Gutenberg work (any work on which the phrase “Project Gutenberg” appears, or with which the phrase “Project Gutenberg” is associated) is accessed, displayed, performed, viewed, copied or distributed:

This eBook is for the use of anyone anywhere in the United States and most other parts of the world at no cost and with almost no restrictions whatsoever. You may

copy it, give it away or re-use it under the terms of the Project Gutenberg™ License included with this eBook or online at [www.gutenberg.org](http://www.gutenberg.org). If you are not located in the United States, you will have to check the laws of the country where you are located before using this eBook.

1.E.2. If an individual Project Gutenberg electronic work is derived from texts not protected by U.S. copyright law (does not contain a notice indicating that it is posted with permission of the copyright holder), the work can be copied and distributed to anyone in the United States without paying any fees or charges. If you are redistributing or providing access to a work with the phrase “Project Gutenberg” associated with or appearing on the work, you must comply either with the requirements of paragraphs 1.E.1 through 1.E.7 or obtain permission for the use of the work and the Project Gutenberg trademark as set forth in paragraphs 1.E.8 or 1.E.9.

1.E.3. If an individual Project Gutenberg electronic work is posted with the permission of the copyright holder, your use and distribution must comply with both paragraphs 1.E.1 through 1.E.7 and any additional terms imposed by the copyright holder. Additional terms will be linked to the Project Gutenberg License for all works posted with the permission of the copyright holder found at the beginning of this work.

1.E.4. Do not unlink or detach or remove the full Project Gutenberg License terms from this work, or any files containing a part of this work or any other work associated with Project Gutenberg.

1.E.5. Do not copy, display, perform, distribute or redistribute this electronic work, or any part of this electronic work, without prominently displaying the sentence set forth in paragraph 1.E.1 with active links or immediate access to the full terms of the Project Gutenberg License.

1.E.6. You may convert to and distribute this work in any binary, compressed, marked up, nonproprietary or proprietary form, including any word processing or hypertext form. However, if you provide access to or distribute copies of a

Project Gutenberg work in a format other than “Plain Vanilla ASCII” or other format used in the official version posted on the official Project Gutenberg website ([www.gutenberg.org](http://www.gutenberg.org)), you must, at no additional cost, fee or expense to the user, provide a copy, a means of exporting a copy, or a means of obtaining a copy upon request, of the work in its original “Plain Vanilla ASCII” or other form. Any alternate format must include the full Project Gutenberg License as specified in paragraph 1.E.1.

1.E.7. Do not charge a fee for access to, viewing, displaying, performing, copying or distributing any Project Gutenberg works unless you comply with paragraph 1.E.8 or 1.E.9.

1.E.8. You may charge a reasonable fee for copies of or providing access to or distributing Project Gutenberg electronic works provided that:

- You pay a royalty fee of 20% of the gross profits you derive from the use of Project Gutenberg works calculated using the method you already use to calculate your applicable taxes. The fee is owed to the owner of the Project Gutenberg trademark, but he has agreed to donate royalties under this paragraph to the Project Gutenberg Literary Archive Foundation. Royalty payments must be paid within 60 days following each date on which you prepare (or are legally required to prepare) your periodic tax returns. Royalty payments should be clearly marked as such and sent to the Project Gutenberg Literary Archive Foundation at the address specified in Section 4, “Information about donations to the Project Gutenberg Literary Archive Foundation.”
- You provide a full refund of any money paid by a user who notifies you in writing (or by e-mail) within 30 days of receipt that s/he does not agree to the terms of the full Project Gutenberg™ License. You must require such a user to return or destroy all copies of the works possessed in a physical medium and discontinue all use of and all access to other copies of Project Gutenberg™ works.

- You provide, in accordance with paragraph 1.F.3, a full refund of any money paid for a work or a replacement copy, if a defect in the electronic work is discovered and reported to you within 90 days of receipt of the work.
- You comply with all other terms of this agreement for free distribution of Project Gutenberg™ works.

1.E.9. If you wish to charge a fee or distribute a Project Gutenberg™ electronic work or group of works on different terms than are set forth in this agreement, you must obtain permission in writing from the Project Gutenberg Literary Archive Foundation, the manager of the Project Gutenberg™ trademark. Contact the Foundation as set forth in Section 3 below.

#### 1.F.

1.F.1. Project Gutenberg volunteers and employees expend considerable effort to identify, do copyright research on, transcribe and proofread works not protected by U.S. copyright law in creating the Project Gutenberg™ collection. Despite these efforts, Project Gutenberg™ electronic works, and the medium on which they may be stored, may contain “Defects,” such as, but not limited to, incomplete, inaccurate or corrupt data, transcription errors, a copyright or other intellectual property infringement, a defective or damaged disk or other medium, a computer virus, or computer codes that damage or cannot be read by your equipment.

1.F.2. LIMITED WARRANTY, DISCLAIMER OF DAMAGES - Except for the “Right of Replacement or Refund” described in paragraph 1.F.3, the Project Gutenberg Literary Archive Foundation, the owner of the Project Gutenberg™ trademark, and any other party distributing a Project Gutenberg™ electronic work under this agreement, disclaim all liability to you for damages, costs and expenses, including legal fees. YOU AGREE THAT YOU HAVE NO REMEDIES FOR NEGLIGENCE, STRICT LIABILITY, BREACH OF WARRANTY OR BREACH OF CONTRACT EXCEPT THOSE PROVIDED IN PARAGRAPH 1.F.3. YOU

AGREE THAT THE FOUNDATION, THE TRADEMARK OWNER, AND ANY DISTRIBUTOR UNDER THIS AGREEMENT WILL NOT BE LIABLE TO YOU FOR ACTUAL, DIRECT, INDIRECT, CONSEQUENTIAL, PUNITIVE OR INCIDENTAL DAMAGES EVEN IF YOU GIVE NOTICE OF THE POSSIBILITY OF SUCH DAMAGE.

**1.F.3. LIMITED RIGHT OF REPLACEMENT OR REFUND**

- If you discover a defect in this electronic work within 90 days of receiving it, you can receive a refund of the money (if any) you paid for it by sending a written explanation to the person you received the work from. If you received the work on a physical medium, you must return the medium with your written explanation. The person or entity that provided you with the defective work may elect to provide a replacement copy in lieu of a refund. If you received the work electronically, the person or entity providing it to you may choose to give you a second opportunity to receive the work electronically in lieu of a refund. If the second copy is also defective, you may demand a refund in writing without further opportunities to fix the problem.

1.F.4. Except for the limited right of replacement or refund set forth in paragraph 1.F.3, this work is provided to you ‘AS-IS’, WITH NO OTHER WARRANTIES OF ANY KIND, EXPRESS OR IMPLIED, INCLUDING BUT NOT LIMITED TO WARRANTIES OF MERCHANTABILITY OR FITNESS FOR ANY PURPOSE.

1.F.5. Some states do not allow disclaimers of certain implied warranties or the exclusion or limitation of certain types of damages. If any disclaimer or limitation set forth in this agreement violates the law of the state applicable to this agreement, the agreement shall be interpreted to make the maximum disclaimer or limitation permitted by the applicable state law. The invalidity or unenforceability of any provision of this agreement shall not void the remaining provisions.

1.F.6. INDEMNITY - You agree to indemnify and hold the Foundation, the trademark owner, any agent or employee of the Foundation, anyone providing copies of Project Gutenberg™ electronic works in accordance with this agreement, and any volunteers associated with the production, promotion and distribution of Project Gutenberg™ electronic works, harmless from all liability, costs and expenses, including legal fees, that arise directly or indirectly from any of the following which you do or cause to occur: (a) distribution of this or any Project Gutenberg work, (b) alteration, modification, or additions or deletions to any Project Gutenberg work, and (c) any Defect you cause.

## **Section 2. Information about the Mission of Project Gutenberg**

Project Gutenberg is synonymous with the free distribution of electronic works in formats readable by the widest variety of computers including obsolete, old, middle-aged and new computers. It exists because of the efforts of hundreds of volunteers and donations from people in all walks of life.

Volunteers and financial support to provide volunteers with the assistance they need are critical to reaching Project Gutenberg's goals and ensuring that the Project Gutenberg collection will remain freely available for generations to come. In 2001, the Project Gutenberg Literary Archive Foundation was created to provide a secure and permanent future for Project Gutenberg and future generations. To learn more about the Project Gutenberg Literary Archive Foundation and how your efforts and donations can help, see Sections 3 and 4 and the Foundation information page at [www.gutenberg.org](http://www.gutenberg.org).

## **Section 3. Information about the Project Gutenberg Literary Archive Foundation**

The Project Gutenberg Literary Archive Foundation is a non-profit 501(c)(3) educational corporation organized under the laws of the state of Mississippi and granted tax exempt status

by the Internal Revenue Service. The Foundation's EIN or federal tax identification number is 64-6221541. Contributions to the Project Gutenberg Literary Archive Foundation are tax deductible to the full extent permitted by U.S. federal laws and your state's laws.

The Foundation's business office is located at 41 Watchung Plaza #516, Montclair NJ 07042, USA, +1 (862) 621-9288. Email contact links and up to date contact information can be found at the Foundation's website and official page at [www.gutenberg.org/contact](http://www.gutenberg.org/contact)

#### **Section 4. Information about Donations to the Project Gutenberg Literary Archive Foundation**

Project Gutenberg™ depends upon and cannot survive without widespread public support and donations to carry out its mission of increasing the number of public domain and licensed works that can be freely distributed in machine-readable form accessible by the widest array of equipment including outdated equipment. Many small donations (\$1 to \$5,000) are particularly important to maintaining tax exempt status with the IRS.

The Foundation is committed to complying with the laws regulating charities and charitable donations in all 50 states of the United States. Compliance requirements are not uniform and it takes a considerable effort, much paperwork and many fees to meet and keep up with these requirements. We do not solicit donations in locations where we have not received written confirmation of compliance. To SEND DONATIONS or determine the status of compliance for any particular state visit [www.gutenberg.org/donate](http://www.gutenberg.org/donate).

While we cannot and do not solicit contributions from states where we have not met the solicitation requirements, we know of no prohibition against accepting unsolicited donations from donors in such states who approach us with offers to donate.

International donations are gratefully accepted, but we cannot make any statements concerning tax treatment of donations received from outside the United States. U.S. laws alone swamp our small staff.

Please check the Project Gutenberg web pages for current donation methods and addresses. Donations are accepted in a number of other ways including checks, online payments and credit card donations. To donate, please visit:  
[www.gutenberg.org/donate](http://www.gutenberg.org/donate).

## **Section 5. General Information About Project Gutenberg electronic works**

Professor Michael S. Hart was the originator of the Project Gutenberg concept of a library of electronic works that could be freely shared with anyone. For forty years, he produced and distributed Project Gutenberg eBooks with only a loose network of volunteer support.

Project Gutenberg eBooks are often created from several printed editions, all of which are confirmed as not protected by copyright in the U.S. unless a copyright notice is included. Thus, we do not necessarily keep eBooks in compliance with any particular paper edition.

Most people start at our website which has the main PG search facility: [www.gutenberg.org](http://www.gutenberg.org).

This website includes information about Project Gutenberg, including how to make donations to the Project Gutenberg Literary Archive Foundation, how to help produce our new eBooks, and how to subscribe to our email newsletter to hear about new eBooks.

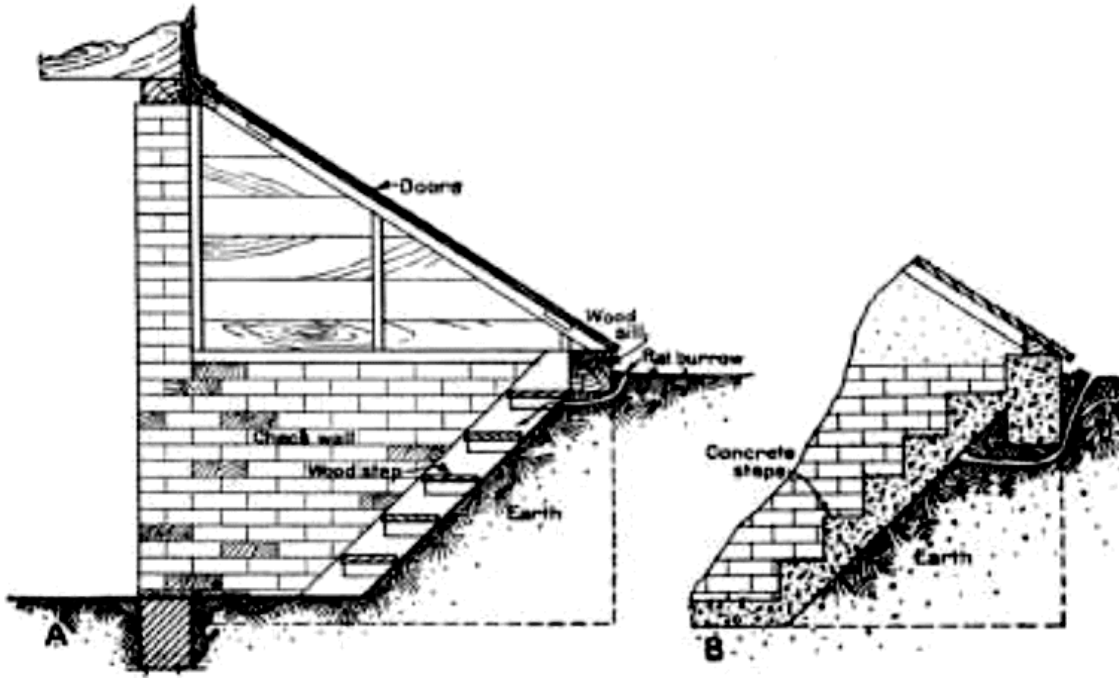

[back](#)